



# Sectional Garage Doors

**NEW: D-ribbed and T-ribbed door styles with embellishments**





## CONTENT

6	Good reasons to try Hörmann
16	Overview of steel sectional doors
20	Overview of solid timber sectional doors
22	Overview of steel surface finishes and types of timber
24	General overview
26	Door styles
56	Colour
62	Manual release
64	Glazings
66	Wicket doors
68	Side doors
70	Modernise and improve
76	Garage door operators
80	Accessories
86	Technology
88	Performance characteristics
90	Dimensions and fitting data
98	Hörmann product range

Some of the doors shown are equipped with optional extras and do not always correspond to our standard models.

The surface finishes and colours shown are subject to the limitations of the printing process and cannot be regarded as binding.

All rights reserved. No part may be reproduced without our prior permission.  
Subject to changes.

◀ M-ribbed in Anthracite grey, RAL 7016, Hörmann aluminium entrance door ThermoSafe style 565, in Anthracite grey, RAL 7016 with optional side elements and transom light



## Benefit from numerous advantages

Sectional doors open vertically upwards and are suspended under the ceiling to save space. This construction principle means you can make full use of the space inside and in front of the garage. In addition, sectional garage doors can be fitted in any garage opening and offer up to 14 cm more passage width than up-and-over doors. They are also optimally sealed with flexible and weather-resistant seals on all four sides.

Treat yourself to this comfort and convenience.





“A good reputation must be earned.”

August Hörmann

In line with the founder's philosophy, the Hörmann brand today is a true promise of quality. The family-owned company has over 75 years of experience in door and operator construction and, with sales of over 20 million doors, is no. 1 in Europe. This makes a Hörmann sectional door a reassuring purchase.



## 1 Brand quality “Made in Germany”

All doors and operator components developed and manufactured by Hörmann are perfectly matched to each other and tested and certified by independent, recognised institutes to ensure your safety. They are manufactured in Germany according to the DIN ISO 9001 quality management system and meet the requirements of European standard 13241-1. Furthermore, our highly qualified employees work intensively on new products, continual further developments and improvements to details. Patents and unique products on the market are the result of this.

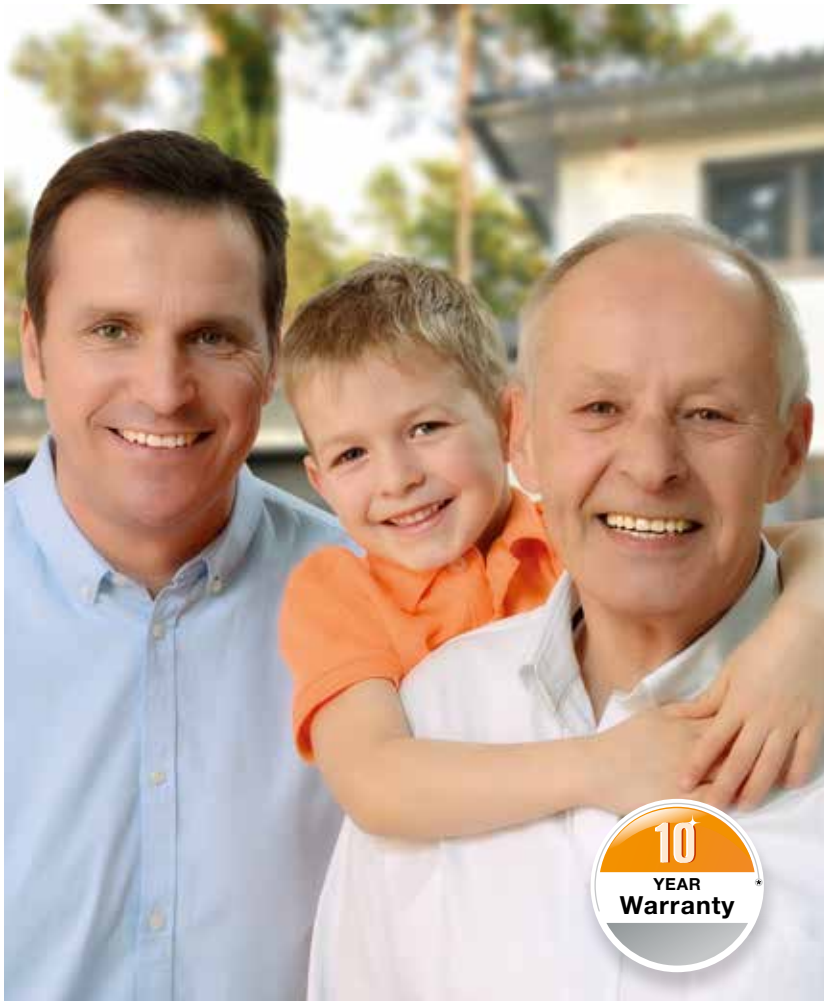

## 2 Garage doors for generations

Endurance tests under real-life conditions ensure mature series products with Hörmann quality. Thanks to this, as well as excellent technical solutions and uncompromising quality assurance, you receive a 10-year warranty on all Hörmann sectional doors and a 5-year warranty on Hörmann operators.\*

\* The complete warranty conditions can be found at: [www.hormann.co.uk](http://www.hormann.co.uk)

## 3 An eye on the future

Hörmann is setting a good example. This is why, since 2013, the company has obtained 40 % of its required energy from green sources and will continue to increase this percentage. At the same time, many tonnes of CO<sub>2</sub> are saved each year thanks to the introduction of an intelligent and certified energy management system. And last but not least, Hörmann also offers products for sustainable construction. Find out more about Hörmann's environmental activities in the "We think green" brochure.

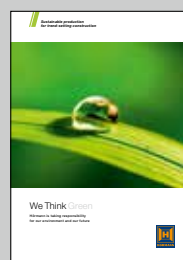



## 4 A harmonious overall appearance

### **1 Even spacing and invisible section transitions for ribbed doors**

Hörmann garage doors are distinguished by even, exact spacing of sections **[A]**. The sections are shaped so that the transitions are practically invisible when the door is closed. See for yourself!

To add to the overall appearance, a practical side door with an alignment matching the sectional garage doors is also available (see page 68).

### **2 Irregular spacing of sections [B], [C]**

due to different section heights coupled with visible section transitions on competitor doors. This gives the door an uneven look.



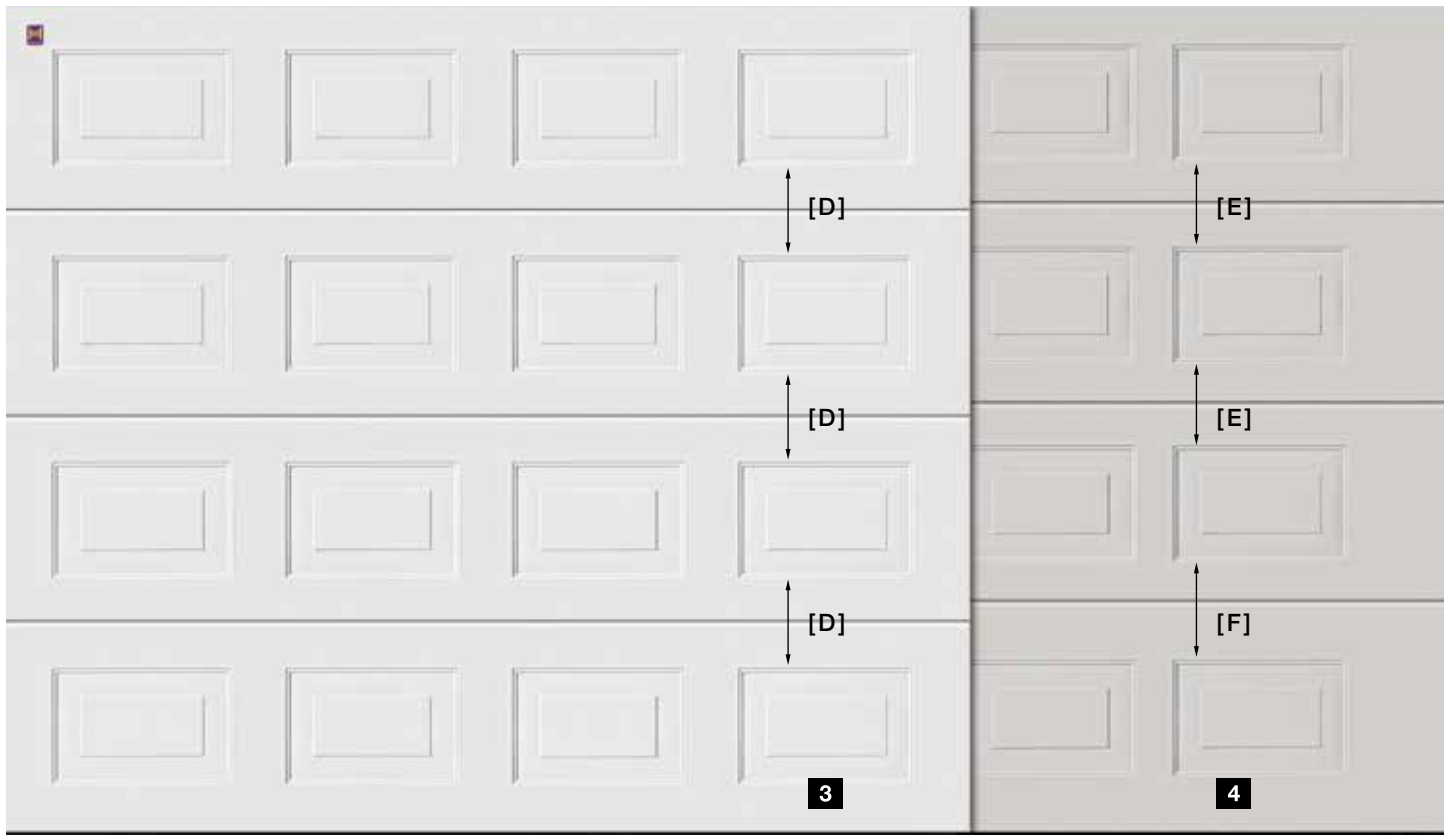

### **3 Uniformly divided panelled doors**

To create a harmonious overall appearance, the height of the spaces between the individual panels **[D]** of Hörmann sectional doors is exactly even. This is achieved by using sections with the same height across the entire door height. The horizontal spacing between the panels within a section is also uniform. This gives the doors an even appearance.

On request, side doors are also available with the same section spacing as the sectional garage door (see page 68).

**4 Irregular panel spacing [E], [F]** due to different section heights on competitor doors. This gives the door an uneven look.

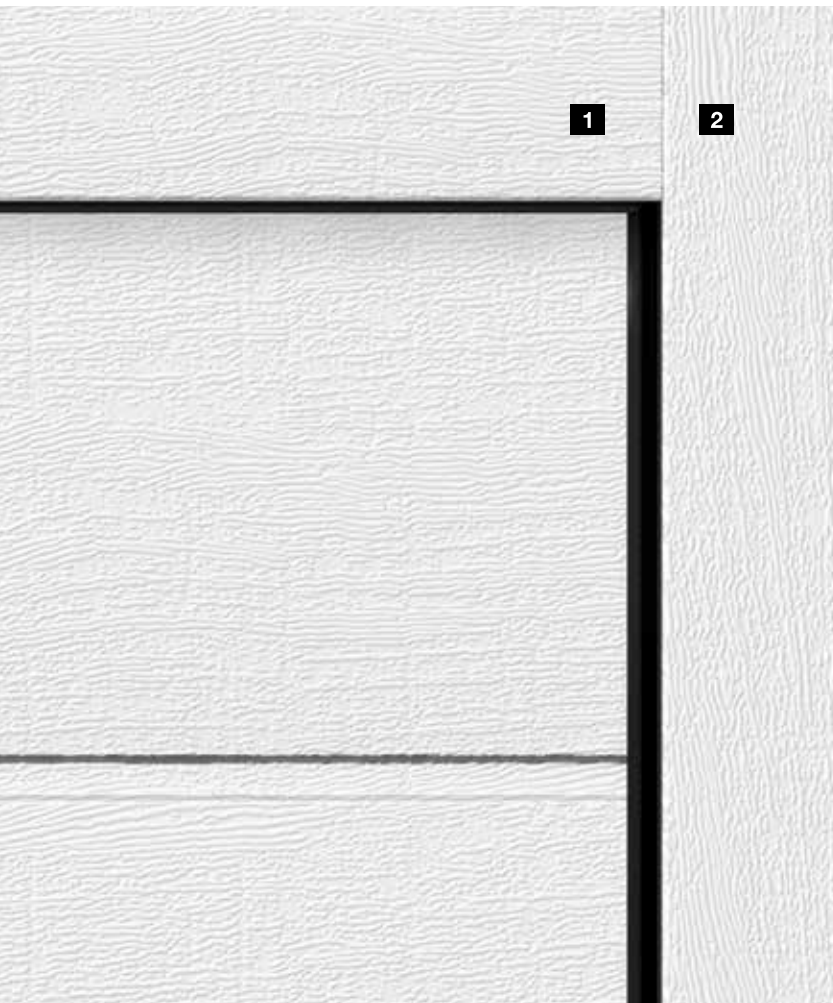

## 5 Matching appearance of frames and door leaves

**!** Only from Hörmann

The harmonious appearance of a door is the result of many small details: For white doors and all surface finishes, the fascia panel **1** is always provided matching the door sections. This ensures that everything fits together. The side frames **2** are available with a white Woodgrain surface finish as standard. For sectional doors with the surface finishes Sandgrain, Silkgrain or Decograin, the frame coverings are optionally available in the surface finish of the door section. For Micrograin doors, the frame covering is provided with a smooth Silkgrain surface finish.

Coloured sectional doors and doors with Decograin surface finishes are also optionally available with frame coverings **2** that match the surface finish and colour or the style of the door sections. The fascia panels **1** for these doors always match the surface finish and colour or style of the door section.

For further information, please see pages 73 – 74.



## 6 Flush-fitting fascia panels

For LPU doors, a flush-fitting fascia panel is the most elegant solution for an invisible transition between the panel and door leaf. When the door is closed, the top door section is flush with the panel.

For further information, please see page 73.

## 7 Detailed Decograin surface finishes

The UV-resistant synthetic foil coating on the exterior of the steel panels has all the aesthetics of timber or an elegant metallic appearance in Anthracite. Thanks to a special surface protection, the 6 Decograin decors remain attractive for a long time.

For further information, please see page 59.



## 8 Optimum long-term protection

A non-brittle, 4 cm plastic frame shoe covers the frame where it is prone to rusting and offers long-term protection against corrosion, even with waterlogging, which is unmatched by competitor solutions. Together with the door's bottom seal, the frame shoe makes for a bottom edge that is visually appealing.

## 9 Efficient thermal insulation

**! Only from Hörmann**

A well-insulated garage door is always recommended when the garage and the home are directly connected. To further improve the already high insulation values, especially of its LPU sectional door, Hörmann has developed the ThermoFrame frame connection, a plastic profile that can be simply fitted together with the door frame.

This creates a thermal break between the frame and the brickwork, improving thermal insulation by up to 15%\*. The optional ThermoFrame frame connection is available for all Hörmann sectional doors.

\* For a double-skinned sectional garage door LPU size 5000 x 2125 mm



# 10 Practical solutions

**! Only from Hörmann**

Wicket doors are recommended for easy passage with a trip-free threshold into your garage. You can also retrieve bicycles or gardening equipment from your garage without opening the door.

The stainless steel threshold is only 10 mm in the centre and 5 mm high at the sides. This makes it easier to wheel things through and reduces the risk of tripping up.

# 11 More security, of course

**! Only from Hörmann**

Uninvited guests barely stand a chance with Hörmann's automatic sectional doors. When the garage door is closed, the anti-lift kit automatically engages in the operator boom's stop, then locks immediately and is secured against forced opening. This patented door latching functions purely mechanically and, in contrast to competitor operators, continues to secure the door even when the power fails.



Take a look at the video at:  
[www.hormann.co.uk/videos](http://www.hormann.co.uk/videos)





## 12 BiSecur radio system with certified security



**Only from Hörmann**

Our bi-directional, high-security BiSecur radio system for garage door and entrance gate operators is based on future-oriented technology that allows you to conveniently and safely operate garage doors, entrance gates, lights and much more.

The newly developed, extremely secure BiSecur encryption protocol with a stable, interference-free range makes sure that no-one can copy your radio signal. Tested and certified by security experts at the Bochum University and as safe as online banking.



Take a look at the video at:  
[www.hormann.co.uk/videos](http://www.hormann.co.uk/videos)





  
 reddot design award
   
 honourable mention 2011

## 13 Convenient querying of the door position

You no longer have to go out in all kinds of weather to check that your garage door is closed. With a single push of a button, the LED colour on the hand transmitter HS 5 BS shows you whether the door is open or closed. If required, another push of a button\* closes the door. It is the most convenient and reliable way to operate your door.

With our new app\*\* and Hörmann BiSecur gateway, you can conveniently control your Hörmann garage door or entrance gate operators, Hörmann entrance door\*\*\* and other devices using your smartphone or tablet.

\* An additional photocell is required for operation without visual contact to the door.

\*\* For iOS and Android operating systems

\*\*\* With special equipment

## 14 Award-winning design

In addition to a black or white design, BiSecur hand transmitters are characterised by an elegant shape that fits easily in the palm of your hand.

Hörmann's BiSecur hand transmitters with an optional high-gloss surface in a piano lacquer look have received the reddot design award for their exclusive design.



Take a look at the video at:  
[www.hormann.co.uk/videos](http://www.hormann.co.uk/videos)



Figure above: HS 5 BS hand transmitter with hand transmitter station (optional).

## LPU

Double-skinned LPU doors offer the best-possible insulation. Moreover, the 42-mm-thick sections give the door the greatest stability and make for quiet operation.

## LTE

Single-skinned LTE doors are the inexpensive solution for detached garages that do not require additional thermal insulation.







S-ribbed (LPU, LTE), Traffic white RAL 9016



M-ribbed (LPU, LTE), Traffic white RAL 9016

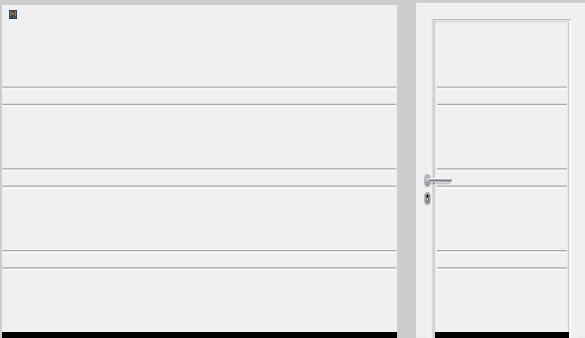

D-ribbed (LPU), Traffic white RAL 9016 ■ **NEW**



T-ribbed (LPU), Traffic white RAL 9016 ■ **NEW**



L-ribbed (LPU), Traffic white RAL 9016



Panelled (LPU, LTE), Traffic white RAL 9016

# OVERVIEW OF STEEL SECTIONAL DOORS



L-ribbed (LPU), style 450, Traffic white RAL 9016



L-ribbed (LPU), style 456, Traffic white RAL 9016

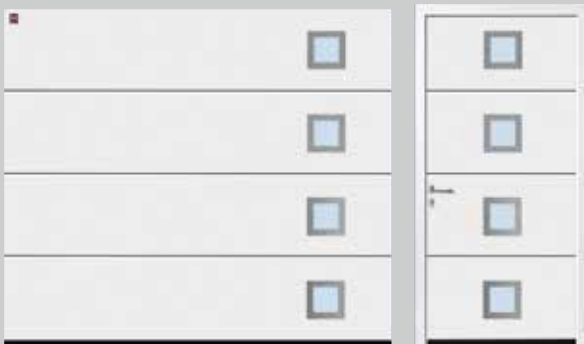

L-ribbed (LPU), style 461 with glazing, Traffic white RAL 9016  
L-ribbed (LPU), style 451 without glazing (not shown)



L-ribbed (LPU), styled 457, arranged to the left, mirrored design, Traffic white RAL 9016



L-ribbed (LPU), style 462 with glazing, Traffic white RAL 9016  
L-ribbed (LPU), style 452 without glazing (not shown)

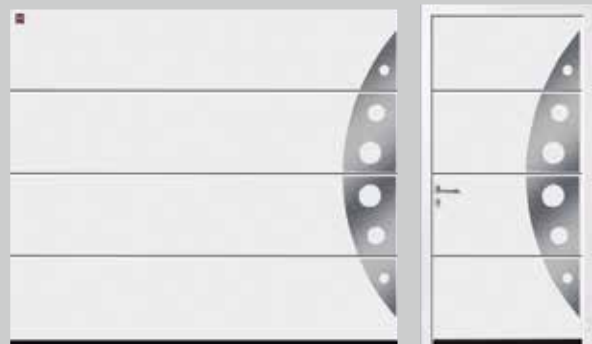

L-ribbed (LPU), style 458, Traffic white RAL 9016



L-ribbed (LPU), style 454, design arranged in the centre, Traffic white RAL 9016



L-ribbed (LPU), style 469 with glazing, Traffic white RAL 9016  
L-ribbed (LPU), style 459 without glazing (not shown)

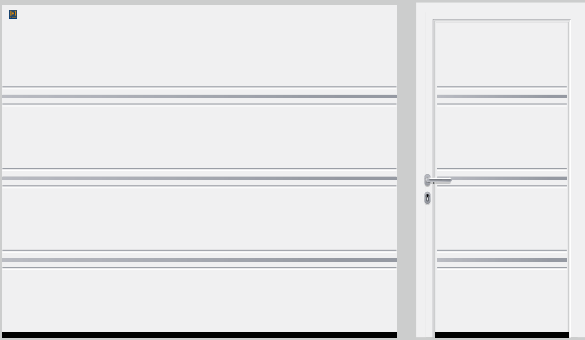

T-ribbed (LPU) style 501 with continuous inlays in stainless steel look ■ **NEW**, Traffic white RAL 9016

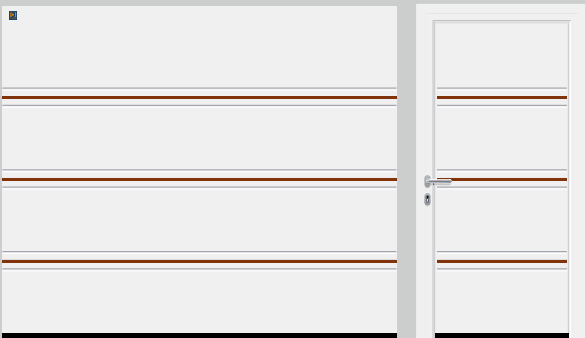

T-ribbed (LPU) style 501 with continuous inlays in timber look ■ **NEW**, Traffic white RAL 9016



T-ribbed (LPU) style 500 with divided inlays in stainless steel look ■ **NEW**, Traffic white RAL 9016

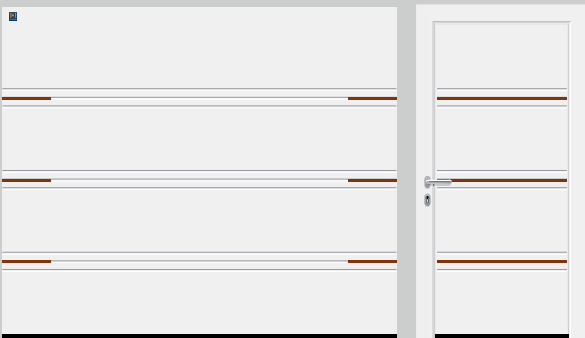

T-ribbed (LPU) style 500 with divided inlays in timber look ■ **NEW**, Traffic white RAL 9016

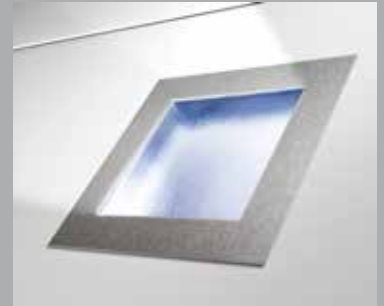

Design element with stainless steel and synthetic glazing



T-ribbed with inlays in stainless steel look



T-ribbed with inlays in timber look

# LTH

Doors made of solid timber panels are excellently suited for timber houses or buildings with many timber elements, such as timber framing or facade elements.



S-ribbed, Nordic Pine



M-ribbed, Nordic Pine

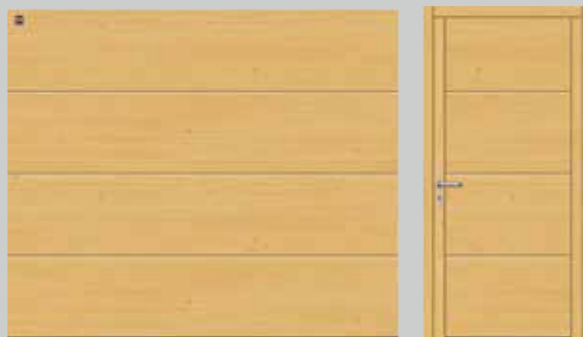

L-ribbed, Nordic Pine



Panelled, Nordic Pine





Style 401, Nordic Pine



Style 402, Nordic Pine



Style 403, Nordic Pine



Style 403 with natural stone, Nordic Pine



Style 404, Nordic Pine



Style 404 with natural stone, Nordic Pine

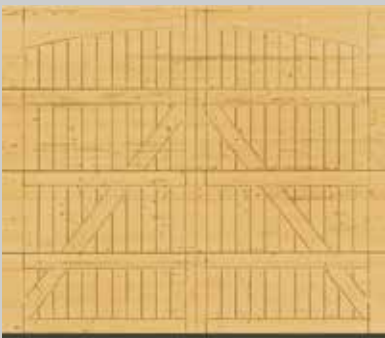

Style 405, Nordic Pine

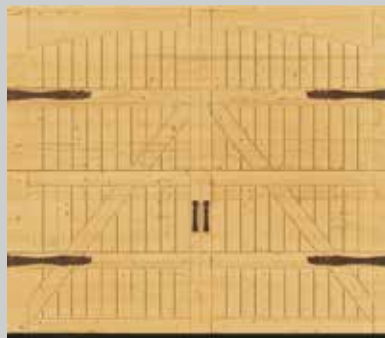

Style 405, with optional hinged door fittings "Exclusive", Nordic Pine



### Individual designs

Design your own timber door: A simple drawing is enough for us to manufacture an individual door for you using a computer-aided mill.

### Setting accents

Choose from 3 natural stones. In styles 403 and 404, natural stone is used as an attractive design feature. Variations in colour and structure are a natural characteristic.



Tropical-green



Multicolour-red



Balmoral-rosso

## It's your choice

Design your garage door to exactly fit your needs. For steel sectional doors you can choose from up to 4 surface finishes that you can adapt to match the colour of your home. Or choose one of 6 Decograin decors with a natural timber look or a decor with an elegant metallic effect. Solid timber sectional doors come in two types of timber that can be individually painted with one of 8 coloured varnishes.

### Steel surface finishes

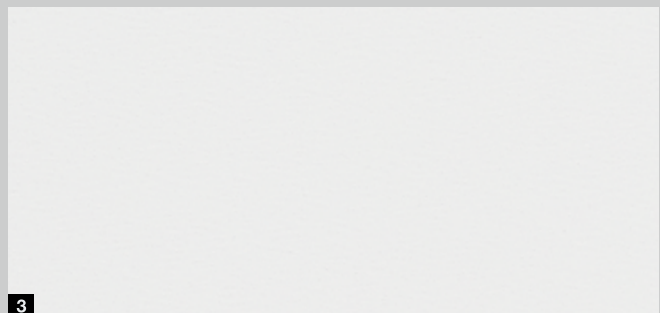

## Types of timber



### 1 Woodgrain

On this inexpensive, robust surface with an authentic sawn timber look, minor scratches can be easily repaired by working with the texture. This surface finish is available in Traffic white RAL 9016, in 15 preferred colours or in RAL to choose.

### 2 Sandgrain

This finely structured surface is an ideal choice for price-conscious owners and is particularly suited for modern homes. Available in Traffic white RAL 9016 and in 3 preferred colours.

### 3 Silkgrain

Thanks to its elegant door appearance, the silky smooth Silkgrain surface finish is the first choice for modern architecture. A 50 % thicker exterior sheet on the sections also ensures higher stability and even smoother running. This surface finish is available in Traffic white RAL 9016, in 15 preferred colours or in RAL to choose.

### 4 Micrograin

This surface features a wave profile that is embossed into smooth steel, producing attractive light and shadow effects. It is available in RAL 9016, in 15 preferred colours or in RAL to choose.

### 5 Decograin

Decograin surface finishes with UV-resistant plastic film coating give your sectional door a striking and authentic timber look or an elegant metallic appearance in Anthracite. You can select from 5 natural timber decors or an elegant metallic decor.

### 6 Nordic Pine

Nordic Pine is a light-coloured softwood with predominantly straight graining. Heart shakes, individual resin pockets, spiral graining and the yellowish brown “knots” are natural characteristics of the wood.

### 7 Hemlock

Hemlock is a greyish white to light-greyish brown softwood with predominantly straight grain, brown mineral stripes along the grain with bark pockets.

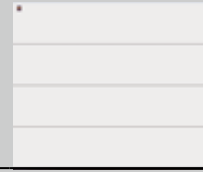
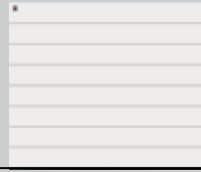
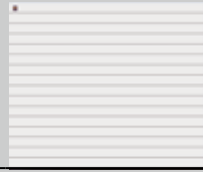

	S-ribbed	M-ribbed	L-ribbed
<b>LPU double-skinned steel sectional doors</b>			
Woodgrain	Traffic white RAL 9016 15 preferred colours RAL to choose	Traffic white RAL 9016 15 preferred colours RAL to choose	Traffic white RAL 9016 15 preferred colours RAL to choose
Sandgrain		Traffic white RAL 9016 3 preferred colours	Traffic white RAL 9016 3 preferred colours
Micrograin			Traffic white RAL 9016 15 preferred colours RAL to choose
Silkgrain*		Traffic white RAL 9016 15 preferred colours RAL to choose	Traffic white RAL 9016 15 preferred colours RAL to choose
Decograin		6 decors	6 decors
Max. width	6000 (7000 <sup>***</sup> ) mm	6000 (7000 <sup>***</sup> ) mm	6000 (7000 <sup>***</sup> ) mm
Max. height	3000 (5000 <sup>***</sup> ) mm	3000 (5000 <sup>***</sup> ) mm	3000 (5000 <sup>***</sup> ) mm
<b>LTE single-skinned steel sectional doors</b>			
Woodgrain	Traffic white RAL 9016	Traffic white RAL 9016	
Max. width	5000 mm	3000 mm	
Max. height	3000 mm	3000 mm	
<b>LTH solid timber sectional doors</b>			
Nordic Pine	8 types of wood preservative	8 types of wood preservative	8 types of wood preservative
Hemlock	8 types of wood preservative	8 types of wood preservative	8 types of wood preservative
Max. width	5000 mm	5000 mm	5000 mm
Max. height	3000 mm	3000 mm	3000 mm

\* L-ribbed with design elements only in Silkgrain surface finish

\*\* Not available in Titan Metallic CH 703

\*\*\* Sectional door SPU F42 Plus



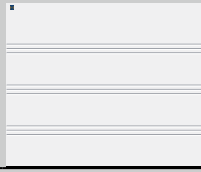
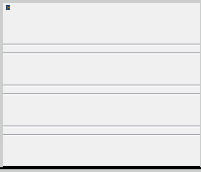

D-ribbed ■ **NEW**

T-ribbed ■ **NEW**

Panelled

Traffic white RAL 9016  
15 preferred colours  
RAL to choose

Traffic white RAL 9016  
15 preferred colours  
RAL to choose

Traffic white RAL 9016  
15 preferred colours  
RAL to choose

5 decors\*\*

6000 mm  
3000 mm

6000 mm  
3000 mm

5500 mm  
3000 mm

Traffic white RAL 9016

3000 mm  
3000 mm

8 types of wood preservative

8 types of wood preservative

5000 mm  
3000 mm





▲ S-ribbed in Woodgrain Fir green RAL 6009



▲ S-ribbed in Woodgrain Anthracite grey RAL 7016;  
Hörmann aluminium entrance door ThermoSafe, style 860 Anthracite grey RAL 7016



▼ S-ribbed in Woodgrain in Traffic white RAL 9016 with matching side door



▲ S-ribbed with solid timber panels in Hemlock





▲ M-ribbed in Decograin Rosewood;  
Hörmann aluminium entrance door ThermoSafe style 845 Window grey RAL 7040

M-RIBBED



► M-ribbed in Silkgrain  
Traffic white RAL 9016  
with LED light strip on lintel







▲ M-ribbed with solid timber panels in Hemlock

◀ M-ribbed in Decograin Titan Metallic CH 703







▲ L-ribbed in Decograin Titan Metallic CH 703



▲ L-ribbed in Silkgrain Anthracite grey RAL 7016;  
aluminium entrance door ThermoSafe style 878

▶ L-ribbed in Decograin Winchester Oak





▼ L-ribbed in Silkgrain Ochre brown RAL 8001



## L-RIBBED

► L-ribbed design style 461 with glazing elements in Decograin Titan Metallic CH 703; Hörmann aluminium entrance door ThermoSafe style 173

▼ L-ribbed design style 450 in Silkgrain Light grey RAL 7035; Hörmann aluminium entrance door ThermoSafe style 693



▲ L-ribbed design style 457 in Silkgrain Traffic white RAL 9016; Hörmann aluminium entrance door ThermoSafe style 188





More information on Hörmann entrance doors can be found in the brochures Aluminium Entrance Doors and ThermoPro Entrance Doors.



▲ D-ribbed in Silkgrain Window grey RAL 7040





▼ D-ribbed in Silkgrain Anthracite grey RAL 7016







▲ T-ribbed style 500 in Silkgrain Anthracite grey RAL 7016 with divided inlays in timber look





◀ T-ribbed style 501 in Silkgrain Anthracite grey RAL 7016 with continuous inlays in stainless steel look

▼ T-ribbed style 501 in Silkgrain Stone grey RAL 7030 with continuous inlays in timber look







▲ Panelled in Decograin Golden Oak

PANELLED



▲ Panelled with solid timber panels in Hemlock with wood preservative in Limestone white

▶ Panelled in Woodgrain Anthracite grey RAL 7016







◀ Panelled in Woodgrain Traffic white RAL 9016







▲ Sectional door ALR F42 with on-site cladding

### Exclusive facade designs

With on-site, flush-fitting facade cladding, you can design your sectional door according to your wishes with timber, metal, ceramic, plastic and many other materials. This way your garage door is seamlessly integrated into the overall design of your home.

The door basis for facade cladding is a Hörmann industrial sectional door ALR F42 with an aluminium frame construction and PU sandwich infill. Please consult with your local Hörmann specialised dealer.



► Sectional door ALR F42 with on-site cladding

▼ Sectional door ALR F42 with on-site cladding





◀ Sectional door ALR F42 Vitraplan

### ALR F42 Vitraplan

The door is especially elegant thanks to offset, flush-fitting glazing. The frame profile is concealed, so nothing detracts from the overall appearance. This exclusive door fascinates with a mix of mirroring and transparency.

► Door style 405, painted white on-site with hinged door fitting kit and decorative handles

▼ Door style 403 in Nordic Pine with tropical green natural stone



◄ Door style 402 in Nordic Pine with a matching side door



### Individual designs

Design your timber door to, for example, display your initials, house number or your favourite motif. Just provide us with an appropriate drawing and we will create a personal garage door for you. It will be an enviable original.

## A bright variety

No matter the architectural style, with Hörmann, you are guaranteed to find a sectional garage door to fit your personal style and home. For steel sectional doors, you can choose from 15 equally-priced preferred colours, approx. 200 RAL colours and 6 Decograin decors.

The door surfaces are optimally protected against rust allowing you to enjoy your new door for a long time. Rain runs off without leaving any streaky marks thanks to the use of hot-galvanized material and a high-quality polyester-primer coating on both sides. Solid timber doors are available in two types of timber, each of which can be glazed in one of 8 colours to match your home.







# Beautiful and protective colour

Double-skinned LPU sectional doors and side doors are available as standard in Traffic white, RAL 9016, as well as in 15 inexpensive preferred colours and in around 200 colours from the RAL colour chart \*, as well as in many NCS and DB colours. You can choose from 3 preferred colours\*\* for the surface finish Sandgrain. Single-skinned LTE doors are only available in Traffic white.

## Standard colour



1

## 15 preferred colours



2

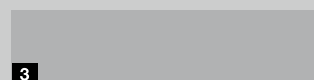

3

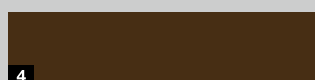

4



5



6



7

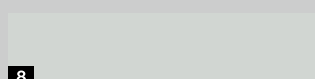

8



9



10



11

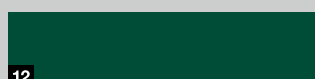

12



13

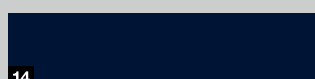

14



15

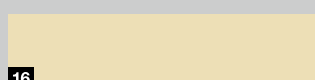

16

- 1 RAL 9016 Traffic white
- 2 RAL 9007 Grey aluminium
- 3 RAL 9006 White aluminium\*\*
- 4 RAL 8028 Terra brown\*\*
- 5 RAL 8003 Clay brown
- 6 RAL 8001 Ochre brown
- 7 RAL 7040 Window grey
- 8 RAL 7035 Light grey
- 9 RAL 7030 Stone grey
- 10 RAL 7016 Anthracite grey\*\*
- 11 RAL 6009 Fir green
- 12 RAL 6005 Moss green
- 13 RAL 5014 Pigeon blue
- 14 RAL 5011 Steel blue
- 15 RAL 3003 Ruby red
- 16 RAL 1015 Light ivory

**Please note:**

Sectional garage doors are generally supplied in Grey white, RAL 9002 on the inside of the door.

Dark colours should not be used for double-skinned steel doors that are exposed to the sun, as possible section deflection may damage the door.

All colours based on RAL.

The colours and surfaces shown are subject to the limitations of the printing process and cannot be regarded as binding. Please seek the expert advice of your Hörmann specialist dealer.

\* With the exception of pearl-effect, fluorescent and metallic colours.

\*\* Preferred colours for Sandgrain surface finish

# Elegance and detailed accuracy

Decograin is available in five natural-looking timber designs and with an anthracite metallic effect. An embossed wood grain gives it an authentic timber character. The door remains beautiful for a long time thanks to the special surface protection of the UV-resistant plastic film coating on the outside of the steel sections.

## 6 Decograin decors

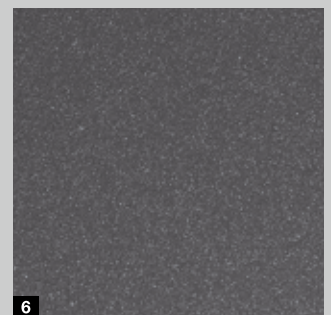
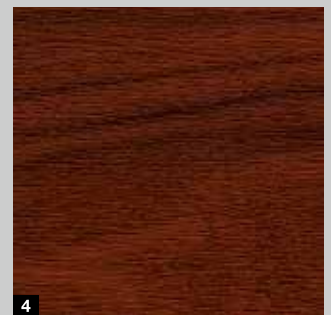
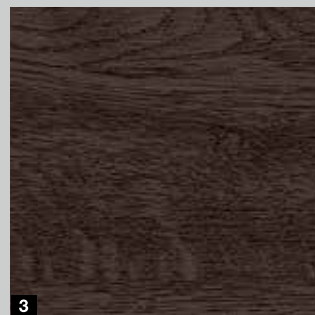
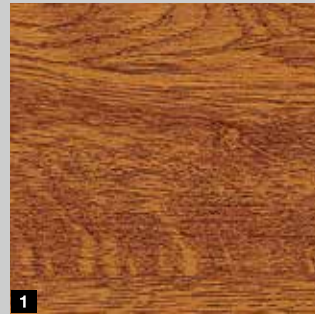

- 1 Decograin Golden Oak: medium brown, golden yellow oak design
- 2 Decograin Dark Oak: walnut-coloured oak decor
- 3 Decograin Night Oak: dark, intense oak design
- 4 Decograin Rosewood: mahogany-coloured timber design
- 5 Decograin Winchester Oak: natural-coloured knotty oak design
- 6 Titan Metallic CH 703: Anthracite with a metallic effect

## Natural types of solid timber

Nordic Pine is a light-coloured softwood with predominantly straight graining. Heart shakes, individual resin pockets, spiral graining and the yellowish brown “knots” are natural characteristics of the wood.

Hemlock is a greyish white to light-greyish brown softwood with predominantly straight grain, brown mineral stripes along the grain with bark pockets.

**Please note:**

The timber is impregnated at the factory to protect it against insect and fungal attack. To protect it from weathering and retain its beautiful appearance, please treat the timber with a wood preservative.

With wood preservatives, the wood content may show through the coating, leading to a change in the surface colour.





## 2 types of solid timber



## 8 types of wood preservative

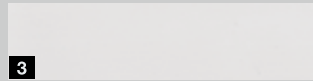

- 1 Nordic Pine, impregnated
- 2 Hemlock, impregnated
- 3 Limestone white
- 4 Pine
- 5 Teak
- 6 Rosewood
- 7 Ebony
- 8 Agate grey
- 9 Fir green
- 10 Nordic red

## Aesthetic, understated, secure

If your garage does not have a second entrance, you can optionally open your automatic garage door from the outside with a beautifully designed handle or an understated emergency release lock.



**Please note:**



1



2



3



4



5



6



7



8

## Door Handles

Hörmann door handles are set apart by a contemporary, modern shape. Here, the selection of material is not just a question of personal taste. For example, stainless steel handles are particularly robust and have a tough surface finish.

The lock can be integrated in the home locking system. Manually operated doors with a handle are locked and break-in-resistant with a latch lock **7**. In this lock, a sturdy, automatic latching disc engages around a massive bolt on the side frame.

## Emergency release

If you do not want a handle on your automatic sectional door, we recommend using an emergency release lock **8**. An inconspicuous round cylinder (cannot be integrated in the home locking system) releases your garage door and you can easily open it in the case of an emergency.

You can also use a lever handle as an emergency release in automatic sectional doors. The door is then unlocked via a Bowden cable on the inside.

- 1** Black plastic
- 2** White cast aluminium, RAL 9016
- 3** Silver cast aluminium
- 4** Brushed stainless steel
- 5** Polished stainless steel
- 6** Brown cast aluminium, RAL 8028
- 7** Latch lock
- 8** Emergency release lock

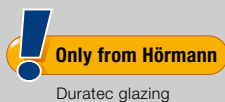

## More light, less energy consumption

Depending on the door type, you can select from various types of glazings with clear (Fig. 2) or textured (right figure) single or double-panes. Clear synthetic glazing from Hörmann comes as standard with DURATEC glazing.

It offers:

- Maximum scratch resistance
- A permanently clear view
- Improved thermal insulation

**Please note:**

Glazing is possible in the two bottom door sections after technical inspection.







1

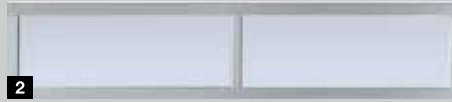

2



3

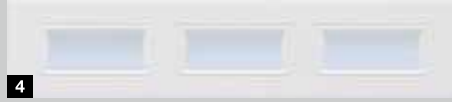

4



5



6



7



8



9



10

- 1 Glazing type D \*
- 2 Aluminium frames\*\*
- 3 Classic glazing S0 \*
- 4 Classic glazing M0 \*
- 5 Classic glazing L0 \*
- 6 Classic glazing S1
- 7 Classic glazing S2
- 8 Sunrise glazing S10
- 9 Sunrise glazing S60
- 10 V-panelled glazing V0

The glazings shown (1-8, 10) correspond to a door width of 2500 mm.

\* Individual arrangement of glazings is possible  
 \*\* Rails are possible

	Glazing type D	Aluminium frame	Classic glazing	Sunrise glazing
<b>Design</b>				
S-ribbed	●	●		
M-ribbed	●	●	●	●
L-ribbed	●	●	●	●
D-ribbed	●	●		
T-ribbed	●	●		
Panelled			●	●
<b>Glazing frames</b>				
Version	Plastic (white or door colour***)	Aluminium, door colour***	Plastic (white or door colour***)	Plastic (white or door colour***)
<b>Glazing</b>				
Single pane Clear/textured	●	●	●	●
Double pane Clear/textured	●	●	●	●

\*\*\* Optional



## An easy passage into your garage

A door in the door lets you easily access whatever you have in your garage, such as gardening tools, bikes or wheelbarrows. Only Hörmann offers a wicket door with a stainless steel threshold that is only 10 mm in the centre and 5 mm high at the sides. This reduces the risk of tripping up and makes it easier to wheel things through. The aluminium door frame is anodised as standard in a natural finish and is also available in the door colour. The top garage door section, also in the wicket door area, comes with a continuous lintel seal.



**Please note:**

On request, Decograin wicket doors can be supplied with the frame painted to match the colour of the decorative finish.

In some cases, adjacent panelled doors with the same width, with and without a wicket door, may not have an identical panel division.

Manually-operated garage doors with a wicket door do not have an outside handle. They are locked from the inside.

The optional leading photocell VL 2 stops the door without contact. This further increases the safety of your garage door with wicket door and trip-free threshold.



### 1 Overhead door closers

As standard, wicket doors are supplied with slide rail door closers incl. integrated opening angle limit and hold-open device (top figure). An integrated door closer, including hold-open device (fig. on bottom) is optionally available for optimum protection and the best appearance.



### 2 Optional multiple-point locking

The wicket door is locked over the entire door height with one bolt and hook bolt per section. The advantage: better stability and improved break-in-resistance.



### 3 Robust door catch

This prevents door-leaf drop and buckling.



### 4 Concealed hinges

For a uniform look, the wicket doors are equipped with concealed hinges as standard.

# A matching side door for every garage door

Design a side entrance to match your garage door.

On request, side doors are also available in the same ribbing or panel division as your sectional door.

## Single-leaf/double-leaf garage side doors

Hörmann side doors are supplied ready-to-fit with profile cylinder mortise lock, round handle/lever handle set with oval rose escutcheons and with 3-way adjustable hinges. Door leaf frames are made of weather-proof aluminium extrusions (depth 60 mm) with all-round seals.



Garage side door	Single-leaf		Double-leaf
	Narrow	Wide	Wide, opening outwards
Leaf frames			
Aluminium block frame	●		●
Aluminium corner frame	●		-
Narrow leaf frame	●		-
Wide leaf frame		●	●
Thermal insulation	U = 2.7 W/(m <sup>2</sup> ·K)		U = 2.9 W/(m <sup>2</sup> ·K)



1

### 1 Lever handle set

Choose between the standard lever handle or many optional lever handle or lever / knob handle sets (Fig: stainless steel lever handle set).



2

### 2 Matching

Decograin side doors come with identical surface finishing for the frame, subframe and door to create a matching appearance.

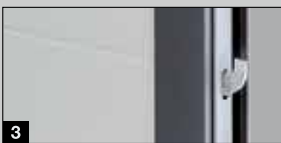

3

### 3 Break-in-resistant

The optional 3-point locking for profile type 2 is equipped with a latch, bolt, 2 locking hooks and security rose escutcheon. The double-leaf side door\* with 3-point locking fulfils break-in resistance class RC 2. This approved resistance class is also recommended by the police. Further information can be found at: [www.k-einbruch.de](http://www.k-einbruch.de)



4

### 4 Insulated version

TopComfort NT80-2 available with door leaf with thermal break, frame and threshold.



## MZ Thermo multi-purpose door

If you highly value good thermal insulation, an MZ Thermo external door with thermal break is the best choice for you. It has an excellent thermal insulation value of 1.2 W/(m<sup>2</sup>·K). An RC 2 version is optionally available (KSI Thermo).

For further information, please see pages 96 / 97 of the fitting data or contact your Hörmann partner.

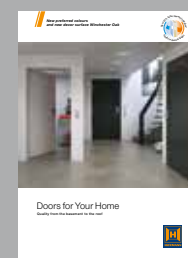

More information can be found in the Doors for Your Home brochure.

## Out with the old, in with the new

At some point it is simply time to modernise your garage door. Hörmann can provide you with an attractive and appropriate solution for any fitting situation. Inexpensive standard sizes, especially created for modernisation, will save you money and get you using your new sectional door faster. Your Hörmann partner also provides you with a complete package of services:

- Qualified consultation
- Measurement on-site
- Professional fitting
- Removal and environmentally-friendly disposal





**HÖRMANN**

Tore • Türen • Zargen • Antriebe



Sprinter CDI

GT JA 19



### Standard fitting

The sectional door can be fitted behind the opening. The reveal guarantees stable fitting. This allows the frame to be screwed directly into the wall behind the opening.

Ideally, the available garage has at least 100 mm of clearance in the lintel area (at least 115 mm for doors with operators) and a 90 mm sideroom.

Hörmann sectional doors come with all the necessary fitting materials for this situation.



### Special anchor for frame side fixing

The sectional door frame can be fitted to the side wall of the garage with Hörmann's optional, universal anchors. Irregularities in the wall can be easily compensated, leaving the reveal intact.

2 Fitting with up to 35 mm wall spacing

3 Fitting with angled or irregular side wall



4 Fitting with non-load bearing facades (facing brick or thermal insulation) with at least 90 and max. 125 mm sideroom

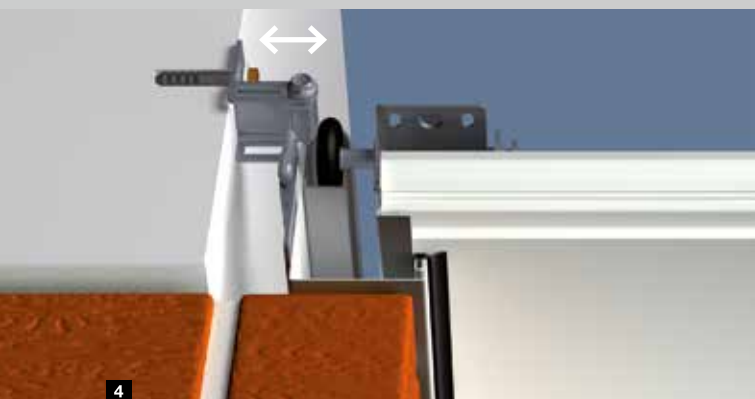





### Fascia panels for standard fitting behind the opening with small lintel space

For all door versions, our standard fascia panels always match the door surface finish and colour or style and can thus be visibly mounted in the opening.



### Double-skinned fascia panel for fitting in the opening with larger gap to the ceiling

A matching, double-skinned additional fascia panel covers the gap between the ceiling and fascia panel. It is available for all surface finishes and colours or designs. Glazings are also possible after technical inspection.

This panel can be optionally supplied as an aluminium frame.



### Flush-fitting fascia panels

For LPU doors, a fascia panel is the most elegant solution for an invisible transition between the panel and door leaf. When the door is closed, the top door section is flush with the panel. It is available for all door styles with all surface finishes and colours or designs (panelled on request).

For further information, please see the fitting data or contact your Hörmann partner.

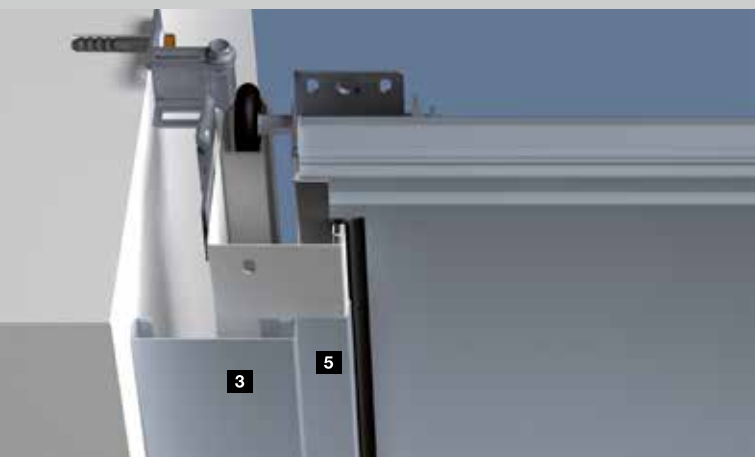
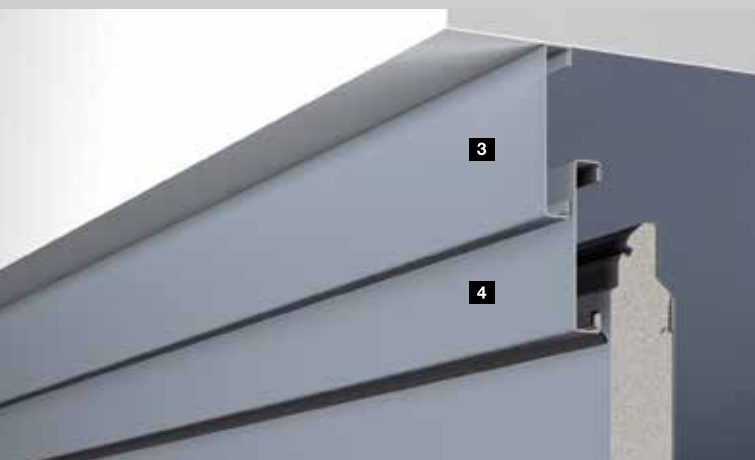
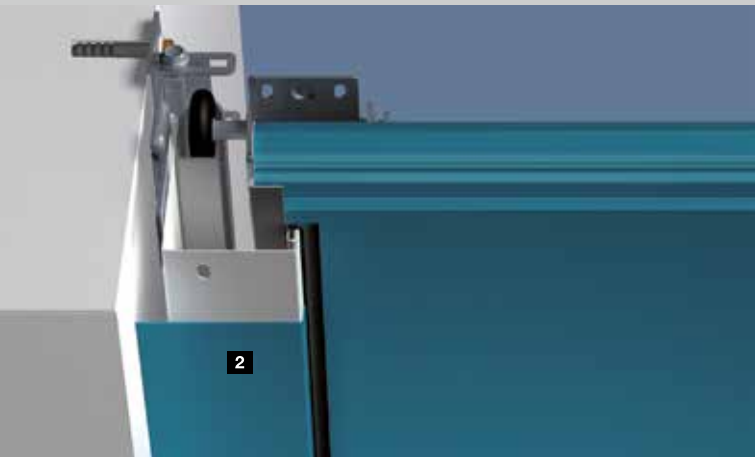
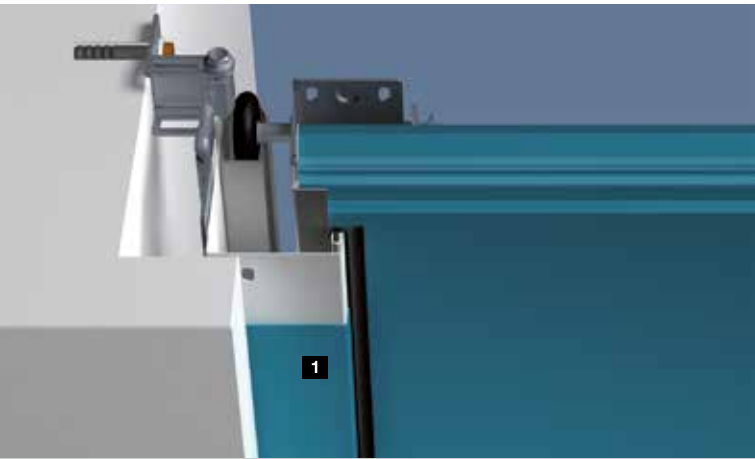

### Frame covering in the colour of the door

At Hörmann, side frames are delivered in Woodgrain white as standard. With a frame covering that matches the door sections' surface finish and colour or decor, you can also achieve a harmonious appearance for sectional doors with Sandgrain, Micrograin, Silkgrain or Decograin surface finishes. For Micrograin doors, the frame covering is delivered with a smooth Silkgrain surface finish.

Two different widths make it possible to cover the side frame for different fitting situations.

**1** 55-mm-wide frame covering for fitting behind the opening, with little sideroom (< 90 mm)

**2** 90-mm-wide frame covering for fitting in the opening, flush with the wall

### Fascia frame set for lintel and side

A door in an inexpensive standard or modernisation size can be fitted in the opening. The remaining gap between the side wall and door frame (max. 35 mm) is covered using a fascia frame set **3**. This set comes with fascia panels in the surface finish and colour or design of the door sections, end caps and fixing materials. For Micrograin doors, the frame covering comes with a smooth Silkgrain surface finish.

The fascia panels **4** match the surface finish and colour or decor of the door as standard. Additionally, the side frame is covered with a frame covering **5** in the surface finish and colour or decor of the door sections.



### Retrofit fascia set to properly cover damaged wall edges

Unattractive gaps in the lintel and opening areas can be covered easily with the optional retrofit fascia, doing away with the need for additional brick laying and plastering work.

The set with 3 fascia panels (each 3 metres long) is available in all surface finishes and colours or decors to match the door. Micrograin doors are supplied with retrofit fascias in a smooth Silkgrain version.



### Overall solution for sectional doors in concrete pre-fabricated garages

Broader fascia panels **1** for fitting in concrete pre-fabricated garages perfectly cover the lintel area of the opening.

The special door frame with pre-fitted anchors and frame fascias **2** is fitted to the side wall or on the conical sideroom. The wide frame fascia covers the existing gap between the frame and the opening.

This door version is available in the surface finishes Woodgrain and Silkgrain in all colours.



For further information, please see the fitting data or contact your Hörmann partner.

## Reliable, safe and maintenance-free

Hörmann garage door operators are perfectly matched to your Hörmann sectional door. The result: simple operation, maximum convenience and the greatest operational safety. Our elegant hand transmitters allow you to open your gate from your car as easily as you would operate a TV. You can also operate your door using stationary control elements, such as a radio code switch or radio finger-scan.

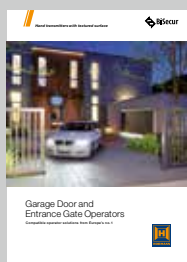

More information can be found in the Garage Door and Entrance Gate Operators brochure.





# SupraMatic, the supra-fast operator with many additional functions



- As standard with a black HS 5 BS hand transmitter and a black HSE 2 BS hand transmitter
- Inquiry of the door position
- Low power consumption
- Easy to program
- 2x 7-segment display
- Halogen lighting can be switched on / off separately
- Adjustable ventilation slot
- Operator cover made of brushed aluminium



HS 5 BS black textured surface with chrome caps

	SupraMatic E	SupraMatic P
Special feature		For timber doors and doors with wicket doors
Equipment		Photocell
Pull and push force	650 N	750 N
Peak force	800 N	1000 N
Opening speed max.	22 cm/s	22 cm/s
Max. door width	5500 mm	6000 mm
Max. door surface	13.75 m <sup>2</sup>	15 m <sup>2</sup>

# ProMatic, the good-value starter model as an introduction to Hörmann's premium quality



- As standard with two black 2-button HSE 2 BS hand transmitters
- Adjustable ventilation slot
- ProMatic Akku for garages without a power connection
- Optional solar module to recharge the battery



HSE 2 BS textured black with plastic caps



ProMatic Akku with solar module

	ProMatic	ProMatic Akku
Special feature		For garages without power connection
Pull and push force	600 N	350 N
Peak force	750 N	400 N
Opening speed max.	14 cm/s	13 cm/s
Max. door width	5000 mm	3000 mm
Max. door surface	11.25 m <sup>2</sup>	8 m <sup>2</sup>

\* The complete warranty conditions can be found at: [www.hormann.co.uk](http://www.hormann.co.uk)

## Mobile and stationary

With Hörmann, everything fits together. Using the same hand transmitter, you can operate your garage door as well as an entrance gate equipped with a fully compatible Hörmann operator or other devices with Hörmann receivers. With the BiSecur app, you can conveniently control your Hörmann garage door or entrance gate operators, Hörmann entrance door\* and other devices using your smartphone or tablet. You can also display the door position for your garage door or entrance gate, as well as the locking state of your entrance door\* while on the go.

\* With special equipment

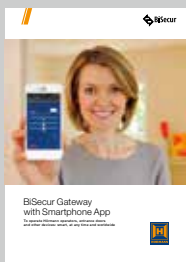

For further information, see the BiSecur Gateway brochure.









**Hand transmitter HS 5 BS**

4 button functions plus query button,

- 1 High-gloss black or white
- 2 Black texture



**Hand transmitter HS 4 BS**

4 button functions,

- 3 High-gloss black

**Hand transmitter HS 1 BS**

1 button function,

- 4 High-gloss black

**Hand transmitter HSE 1 BS**

1 button function, incl. eyelet for key ring

- 5 High-gloss black



**Hand transmitter HSE 2 BS**

2 button functions incl. eyelet for key ring

- 6 High-gloss black or white
- 7 High-gloss green, purple, yellow, red, orange

(Shown from left to right)



- 8 Textured black with chrome or plastic caps
- 9 Decors in silver, carbon, light rootwood, light timber, dark timber, dark rootwood

(Shown from left to right)



**10 Hand transmitter  
HSD 2-A BS**

Aluminium look,  
2 button functions,  
can also be used as a key ring

**11 Hand transmitter  
HSD 2-C BS**

High-gloss chrome,  
2 button functions,  
can also be used as a key ring



**12 Hand transmitter HSP 4 BS**

4 button functions,  
with button lock-out,  
incl. key ring



**13 Hand transmitter HSZ 1 BS**

1 button function,  
for insertion in vehicle  
cigarette lighter

**14 Hand transmitter HSZ 2 BS**

2 button functions,  
for insertion in vehicle  
cigarette lighter



**Hand transmitter**

Hörmann offers numerous beautifully shaped models that can be assigned up to 5 functions. All control elements use our innovative BiSecur radio technology.



**HSZ hand transmitter**

The alternative to homelink systems: integrated in an inconspicuous spot in your car. Inserted in the vehicle's cigarette lighter, the HSZ hand transmitter is easily accessible and convenient to operate.



**Radio code switch  
FCT 3 BS**  
For 3 functions,  
with illuminated buttons



**Internal push button  
IT 1b**  
Large, illuminated button  
for convenient opening  
of the door (for ProMatic  
and SupraMatic).



**Radio code switch  
FCT 10 BS**  
For 10 functions,  
with illuminated buttons  
and protective cover



**Internal push button  
IT 3b**  
Large, illuminated button  
for convenient opening  
of the door, two additional  
buttons for the operator light  
and to switch off radio control,  
e.g. while on holiday  
(for SupraMatic).



**Radio finger-scan  
FFL 12 BS**  
For 2 functions  
and up to 12 fingerprints

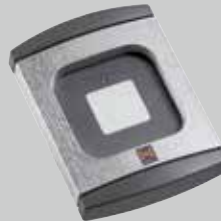

**Transponder key switch  
TTR 100 / TTR 1000**  
For 1 function  
with 2 keys (more on request)  
for up to 12 / 100 / 1000 keys.



**Key switch  
STUP 40 / STAP 40**  
In a recessed version  
and surface-mounted version,  
including 3 keys



**Radio internal push  
button FIT 2**  
For 2 functions  
or 2 operators



**Code switch  
CTV 1 / CTV 3**  
For 1 or 3 functions,  
especially robust,  
protected against vandalism.



**Photocell EL 101**

One-way photocell system, immediately stops the door when the light beam is interrupted



**Emergency battery HNA for garage door operators**

Emergency power supply to bypass power failures up to 18 hours and max. 5 door cycles, recharges during normal operation, for all current Hörmann garage door operators



**Radio internal push button FIT-1**  
1 button function with large button for simple operation ■ **NEW**



**Radio internal push button FIT-4**  
4 button functions ■ **NEW** from Autumn 2015



**Radio internal push button FIT-5**  
4 button functions plus query button ■ **NEW** from Autumn 2015

**LED light strip**

Neutral white light, variable plug-in system, can be fitted to lintel or bottom edge of door leaf, LED spacing: 125 mm, energy efficiency class A



## Operating comfort with the highest security



Safety while operating the garage door is top priority for Hörmann. And Hörmann sets the standards for this with its innovative solutions. This has been proven time and time again through numerous Hörmann patents. Hörmann sectional doors are tested and certified in accordance with the high safety requirements of European standard 13241-1, not only on their own but also in combination with operators. It would be hard to find a safer sectional door.

And this provides you and your family with safety during daily use.

It pays to compare!





**1 Tension spring assembly with spring-in-spring system**

Double tension springs and double cabling on each side safeguard the door leaf against crashing to the floor. Thanks to the patented spring-in-spring system, broken springs are prevented from flying out and causing injuries. Sectional doors up to 3000 mm wide and 2625 mm high include the proven tension spring technology as standard.

Hörmann patent



**2 Torsion spring assembly with integrated spring safety device**

Torsion springs on both sides feature a patented spring safety device. In the event of a spring breaking, they arrest the door immediately, thereby preventing the door leaf from crashing to the floor. Larger sectional doors and doors with integral wicket door or garage doors with solid timber panels feature torsion spring technology.

Hörmann patent



**3 Secure guidance of the door in safety tracks**

Patented, adjustable track rollers, sturdy roller holders and safety tracks ensure that there is no danger of the door "derailing". The door sections are safely parked under the ceiling.

Hörmann patent



**4 Finger trap protection on the inside, outside and on the hinges**

The unique form of the door sections eliminates trap points, both between the sections and on the hinges.



**5 Trap guard on the side frame**

With Hörmann, the frames are completely closed from top to bottom. There are no gaps between the door leaf and frame in which fingers could get trapped!

## Optimum thermal insulation



A well-insulated garage door is always recommended when the garage and the home are directly connected. The ThermoFrame frame connection further improves the already high insulation values of the double-skinned Hörmann sectional garage doors.

This reduces your energy costs.



Improved thermal insulation with ThermoFrame

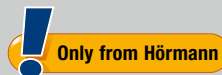

The plastic profile that can be simply fitted together with the door frame, creates a thermal break between the frame and the brickwork, improving the thermal insulation by up to 15%\*. In addition, extra lip seals on both sides and in the upper section of the door provide better sealing while lowering the loss of heating energy from the garage interior. The ThermoFrame frame connection is optionally available for all Hörmann sectional garage doors.



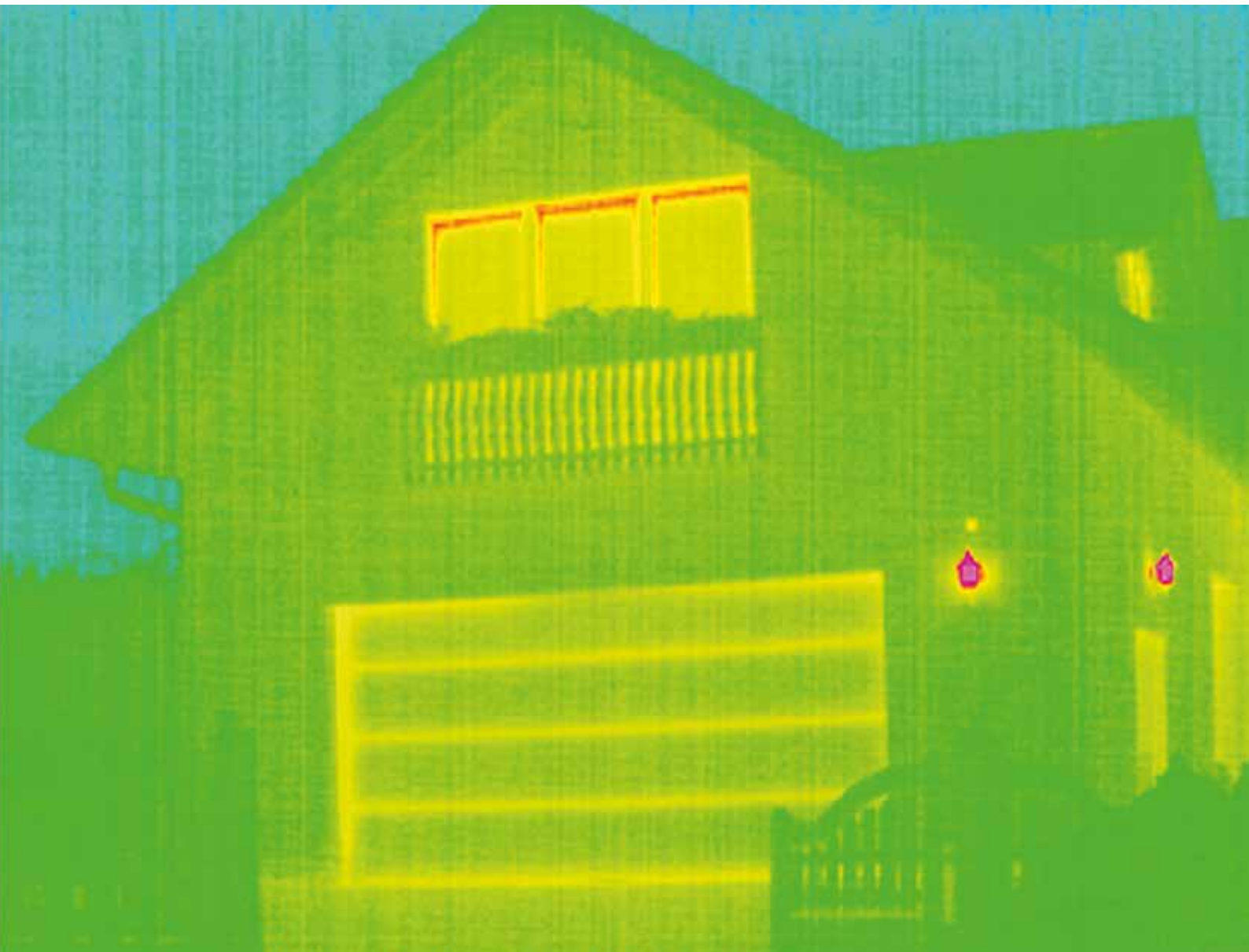

## Performance characteristics according to European standard 13241-1

Door type	Thermal insulation	Acoustic insulation	Sealing		Wind load <sup>5)</sup>
			Air	Water	
<b>LTE</b>		R = approx.20 dB			
Door leaf	U = 6.0 W/(m <sup>2</sup> ·K)		Class 0 <sup>2)</sup>	Class 0 <sup>2)</sup>	Class 2
Fitted door <sup>1)</sup>	U = 6.5 W/(m <sup>2</sup> ·K)				
<b>LPU</b>		R = approx.25 dB			
Section	U = 0.5 W/(m <sup>2</sup> ·K)		Class 3 <sup>4)</sup>	Class 3 <sup>3)</sup>	Class 3
Door leaf	U = 0.9 W/(m <sup>2</sup> ·K)				
Fitted door <sup>1)</sup>	U = 1.4 W/(m <sup>2</sup> ·K)				
<b>LTH</b>					
Door leaf	U = 2.5 W/(m <sup>2</sup> ·K)		Class 0 <sup>2)</sup>	Class 0 <sup>2)</sup>	Class 3
Fitted door <sup>1)</sup>	U = 3.0 W/(m <sup>2</sup> ·K)				

<sup>1)</sup> The U-values apply to fitted doors without glazing in the size: 5000 × 2125 mm

<sup>2)</sup> Doors with ventilation slots, on request classes 2 – 3

<sup>3)</sup> Up to 70 Pa water pressure

<sup>4)</sup> Valid for panelled and L-ribbed (LPU doors S, M, D or T-ribbed: class 2)

<sup>5)</sup> Higher wind load classes on request

### Door types LPU, LTE

Size range		Door width grid (LZ)																		
Door height grid (RM)	3000							•												
	2875																			
	2750			•		•														
	2625																			
	2500			•		•	•													
	2375			•		•	•													
	2250	•	•	•		•	•	•	•	•	•	•	•	•	•		•	•		
	2125	•	•	•	•	•	•	•	•	•	•	•	•	•	•		•	•		
	2080	•	•	•		•	•													
	2000	•	•	•		•	•	•	•	•	•	•	•	•			•	•		
	1875	•	•	•		•	•													
Interior garage dimension (GIM)		2430	2565	2680	2805	2930	3180	3430	3680	3930	4180	4430	4680	4930	5180	5430	5680	6000		
Door width grid (LZ)		2250	2375	2500	2625	2750	3000	3250	3500	3750	4000	4250	4500	4750	5000	5250	5500	6000		

Modernisation sizes*		LZ				GIM															
Door height grid (RM)	2205			•	•																
	2080	•	•	•	•																
	1955	•	•	•																	
		2190	2315	2440	2940																
		2370	2495	2620	3120																

\* Not available for panel styles with Decograin surface finishes and solid timber doors

### Door types LPU, LTE

Size range for track applications							Modernisation sizes			
Door height grid (RM)	Track application Z		Track application N		Track application L		Track application Z			
	Min. DE	LDH	Min. DE	LDH	Min. DE	LDH*	Min. DE	LDH		
With operator							With operator			
3000				3210	3000	3115	2970			
2875				3085	2875	2990	2845			
2750				2960	2750	2865	2720			
2625	2740	2595	2835	2625	2740	2595				
2500	2615	2470	2710	2500	2615	2470				
2375	2490	2345	2585	2375	2490	2345				
2250	2365	2220	2460	2250	2365	2220				
2125	2240	2095	2335	2125	2240	2095				
2000	2115	1970	2210	2000	2115	1970				
1875	1990	1845	2085	1875	1990	1845				
Door height grid (RM)	With manual operation		With manual operation		With manual operation		With manual operation			
	3000				3210	2950	3100	2900		
	2875				3085	2825	2975	2775		
	2750				2960	2700	2850	2650		
	2625	2725	2545	2835	2575	2725	2525			
	2500	2600	2420	2710	2450	2600	2400			
	2375	2475	2295	2585	2325	2475	2275			
	2250	2350	2170	2460	2200	2350	2150			
	2125	2225	2045	2335	2075	2225	2025			
	2000	2100	1920	2210	1950	2100	1900			
	1875	1975	1795	2085	1825	1975	1775			
Door height grid (RM)										
		2205	2320	2175						
		2080	2195	2050						
		1955	2070	1925						
		2205	2305	2125						
		2080	2180	2000						
		1955	2055	1875						

## Track Applications

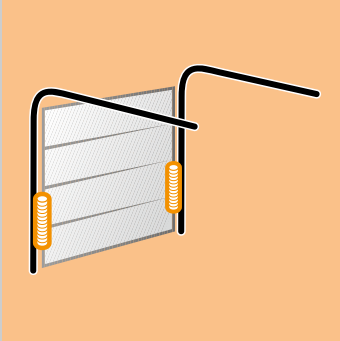

### Track application Z

Tension spring track application  
with tension spring assembly  
Max. width 3000 mm  
Max. height 2625 mm

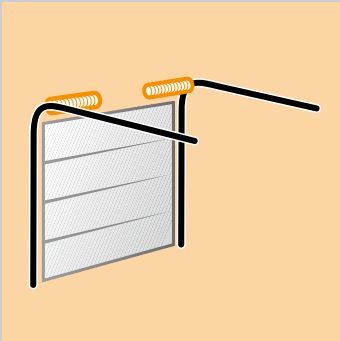

### Track application N

Normal track application  
with torsion spring assembly  
Max. width 6000 mm  
Max. height 3000 mm

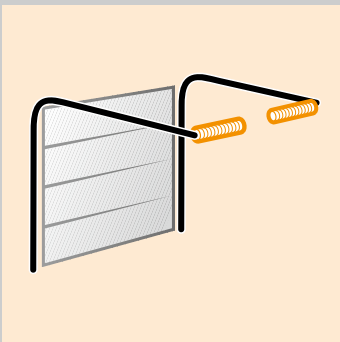

### Track application L

Low-headroom tracks  
with torsion spring assembly  
Max. width 6000 mm  
Max. height 3000 mm

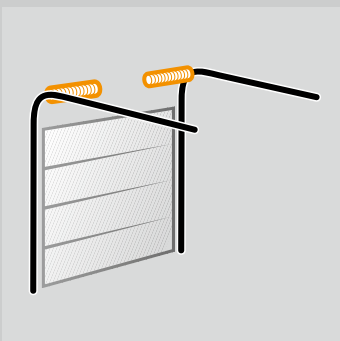

### Track application H

High-lift track application  
with torsion spring assembly  
Max. width 5500 mm  
Max. height 3000 mm

## Explanations

If you are interested in this track version for high-lift doors, contact your Hörmann specialist dealer.

LZ Clear frame dimensions  
RM Grid height

DE Ceiling height

#### **Track application N:**

\*\* With ThermoFrame and operator + 45 mm

#### **Track application Z/L:**

\*\* With ThermoFrame and operator + 30 mm

LDH Clear passage height

#### **Track application L:**

\* With doors over 3010 mm wide, the clear passage is reduced by a further 50 mm.

GIM Inside garage dimension

ET Distance back

#### **Note**

Timber doors are not supplied with track application Z

Horizontal view

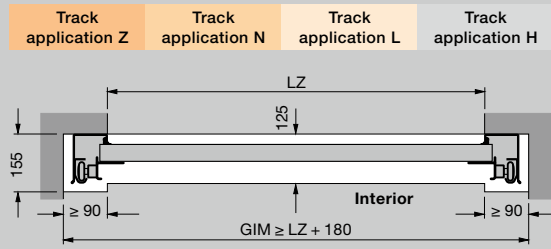

Fitting with track applications Z, N, L

Overall length operators	Track application Z	Track application N	Track application L
Doors with operator			
	2125 (K)	3200	3200
	2250 (K)	3200	3200
Max. door height	2375 (M)	3450	3450
	2500 (M)	3450	3450
	3000 (L)	4125	4125

Vertical views

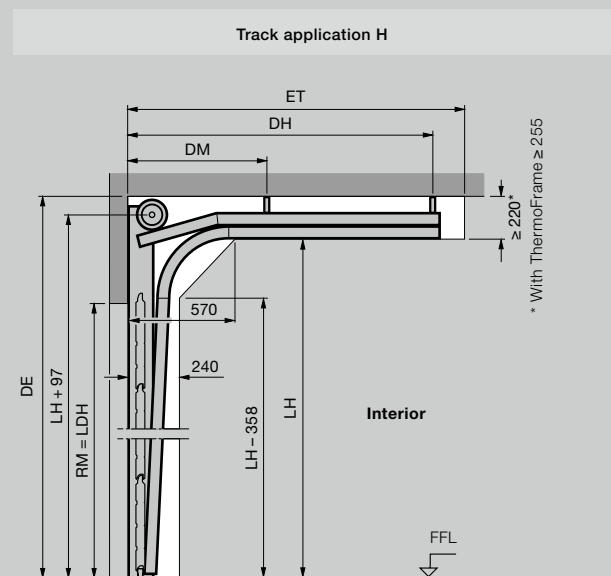
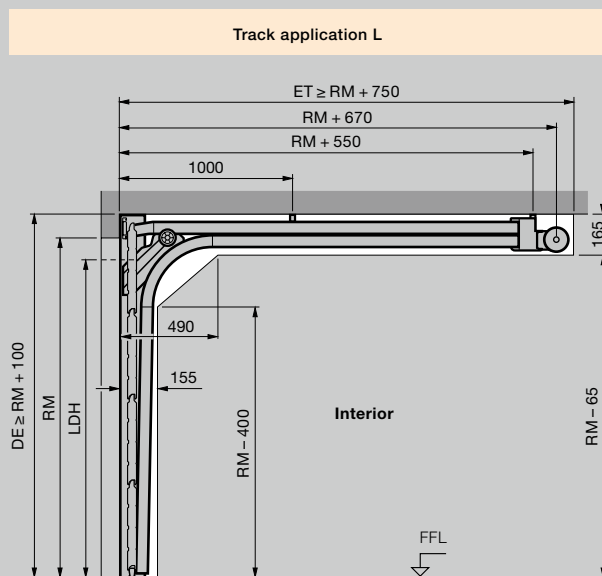
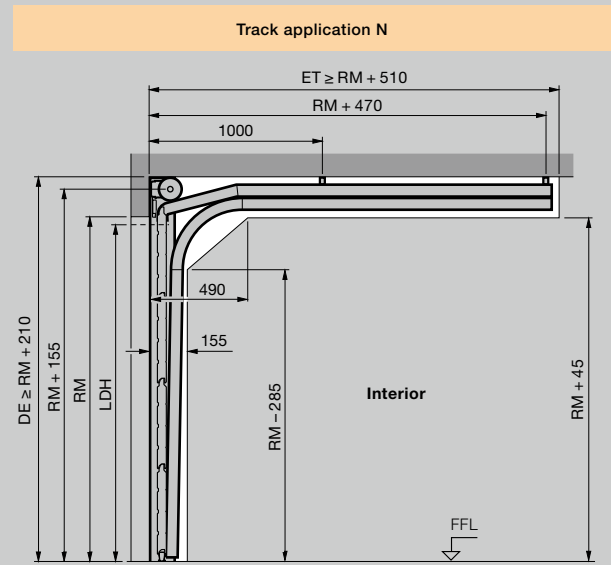
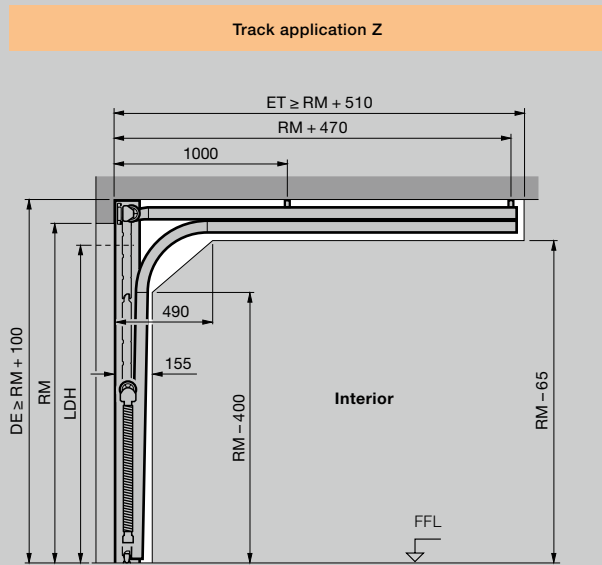

## Fitting with flush-fitting panel

Overall length operators	Track application BZ	Track application BL
Doors with operator		
	2125 (K)	3272
Max. door height	2375 (M)	3522
	3000 (L)	4197

## Vertical views

Track application BZ    Track application BL    Without lintel

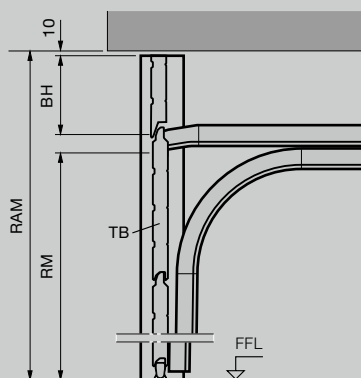

Track application BZ    Track application BL    With lintel

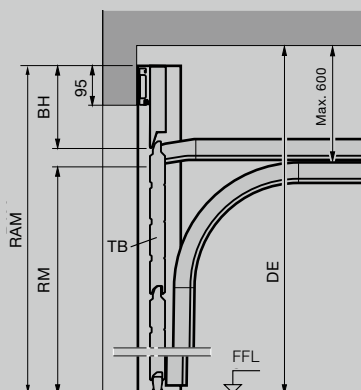

Dimensions in mm

## Explanations

### Drive booms

- K Short boom
- M Medium boom
- L Long boom

### Track applications

- Z Tension spring track application
- N Normal track application
- L Low headroom track application
- H High-lift track application\*
- BZ Tension spring track application with flush-fitting panels
- BL Low-lintel track application with flush-fitting panels

### Ordering sizes

- LZ Clear frame dimensions
- RM Grid height
- RAM Overall frame dimension (of flush-fitting panels)  
Min. = RM + 240 mm  
Max. = RM + 600 mm (door section height)

### DE Ceiling height

#### Track application N:

- Manual operation  $\geq$  RM + 210 mm
- With operator  $\geq$  RM + 210 mm
- With operator and ThermoFrame  $\geq$  RM + 255 mm

#### Track application Z/L:

- Manual operation  $\geq$  RM + 100 mm
- With operator  $\geq$  RM + 115 mm
- With operator and ThermoFrame  $\geq$  RM + 145 mm

### LDH Clear passage height

#### Track application N:

- Manual operation = RM - 50 mm
- With operator = RM

#### Track application Z/BZ:

- Manual operation = RM - 80 mm
- With operator = RM - 30 mm

#### Track application L/BL:

- Manual operation = RM - 100 mm
- With operator (LZ < 3000) = RM - 30 mm
- With operator (LZ > 3000) = RM - 80 mm

### GIM Inside garage dimension

- ET Distance back
- TB Door leaf
- BH Panel height
- LH Track height
- DM Ceiling suspension, centre
- DH Ceiling suspension, back
- FFL Finished floor level

### Note

Before fitting a sectional door, the structural openings must be finished and the floors be laid and level. The clearance required for fitting the door must be free of supply lines, heater fans, etc.

\* For further information, please see the fitting data or contact your Hörmann partner.

Wicket doors with ribbing

Size range										
Door height grid (RM)	3000									
	2875	○	○	○	○	○	○	○	○	○
	2750									
	2625	○	○	○	○	○	○	○	○	○
	2500									
	2375									
	2250									
	2205									
	2125									
	2080									
	2000									
	1955									
	1875									
			2250	2375	2500	2750	3000	3250	3500	3750
		Door width grid (LZ)								

Wicket doors with ribbing

	Clear passage height		Lever height from FFL
	Without glazing	With glazing	
	1955	1955	831
	1871	1871	799
	2155	2155	906
	2055	2055	868
	1955	1955	831
	1855	1855	793
	2123	2203	924
	2075	2155	906
	1999	2079	877
	1955	2035	861
	1875	1955	831
	1827	1907	813
	1747	1827	782

Doors with wicket doors with panels

Size range										
Door height grid (RM)	3000									
	2875	□	□	□	□	□	□	□	□	□
	2750	□	□	□	□	□	□	□	□	□
	2625	□	□	□	□	□	□	□	□	□
	2500									
	2375									
	2250									
	2205	□	□	□	□	□	□	□	□	□
	2125									
	2080	□	□	□	□	□	□	□	□	□
	2000									
	1955	□	□	□	□	□	□	□	□	□
	1875									
			2250	2500	2750	3000	3250	3500	3750	4000
		Door width grid (LZ)								

Wicket doors with panels

	Clear passage height	Lever height from FFL
		1955
	1871	799
	2155	906
	2055	868
	1955	831
	1855	793
	2203	924
	2155	906
	2079	877
	2035	861
	1955	831
	1907	813
	1827	782

○ = Not possible with Decograin, Micrograin Sandgrain and Silkgrain  
 □ = Not possible with Decograin

## Horizontal view

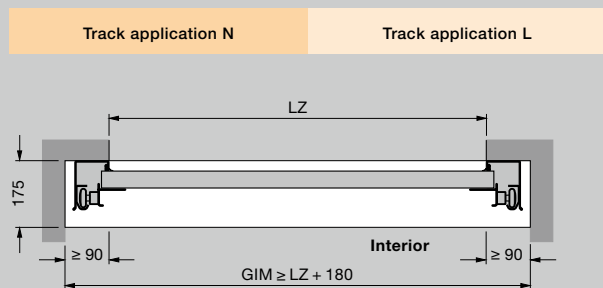

## Vertical views

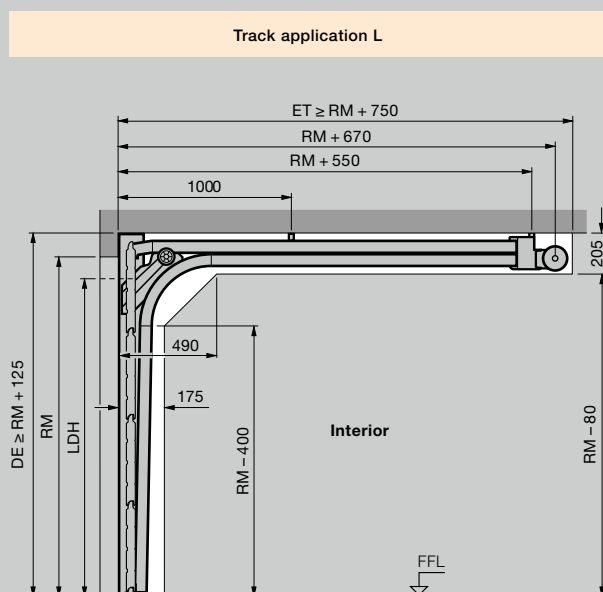
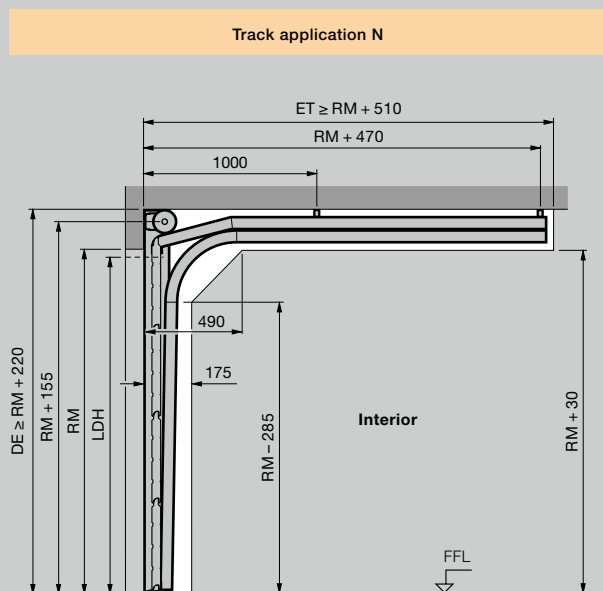

Dimensions in mm

## Explanations

### Track applications

- N Normal track application
- L Low headroom track application

### Ordering sizes

- LZ Clear frame dimensions
- RM Grid height
- DE Ceiling height

### Track application N:

- Manual operation  $\geq RM + 220$  mm
- With operator  $\geq RM + 235$  mm
- With operator and ThermoFrame  $\geq RM + 255$  mm

### Track application L:

- Manual operation  $\geq RM + 125$  mm
- With operator  $\geq RM + 125$  mm
- With operator and ThermoFrame  $\geq RM + 145$  mm

- LDH Clear passage height

### Track application N:

- Manual operation =  $RM - 160$  mm
- With operator =  $RM - 100$  mm

### Track application L:

- Manual operation =  $RM - 160$  mm
- With operator =  $RM - 160$  mm

- GIM Inside garage dimension
- ET Distance back
- FFL Finished floor level

### Fitting with ThermoFrame

- Fitting with ThermoFrame LDB =  $LZ - 12$  mm
- Fitting with ThermoFrame and frame covering LDB =  $LZ - 15$  mm
- Fitting with ThermoFrame and operator Track application N + 20 mm
- Track application L + 20 mm

### Note

The opening height must not be less than the ordering size of the garage door (RM), otherwise the wicket door will not open.

For further information, please see the fitting data or contact your Hörmann partner.

Horizontal views

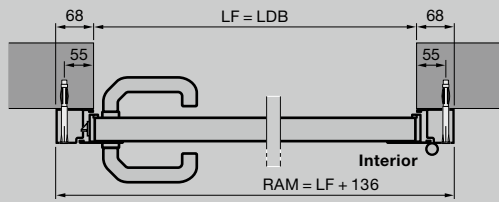

Side door with aluminium block frame, profile type 1  
Fitting behind the opening

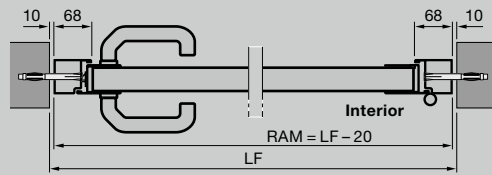

Side door with aluminium block frame, profile type 2  
Fitting in the opening

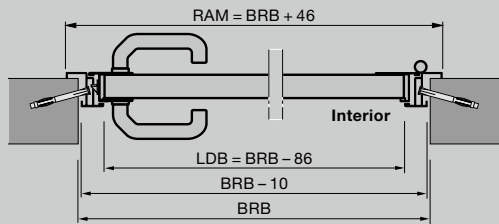

Side door with aluminium corner frame, profile type 3  
External fitting

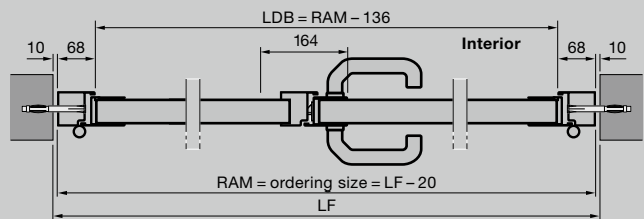

Double-leaf side door with aluminium block frame, profile type 2  
Fitting in the opening

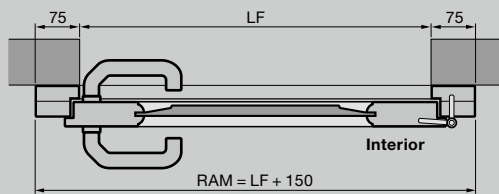

Solid timber side door  
Fitting behind the opening

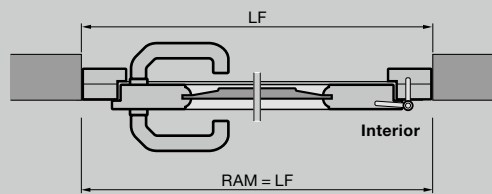

Solid timber side door  
Fitting in the opening

Vertical views

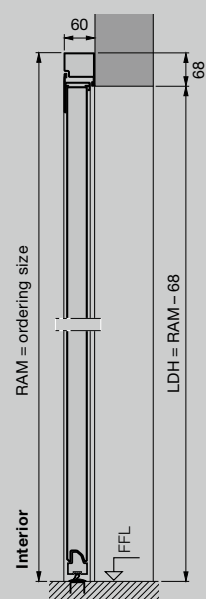

Side door with aluminium block frame, profile type 2  
Fitting behind the opening

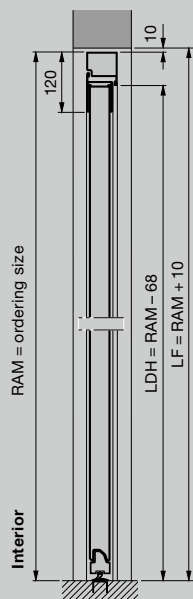

Side door with aluminium block frame, profile type 2  
Fitting in the opening

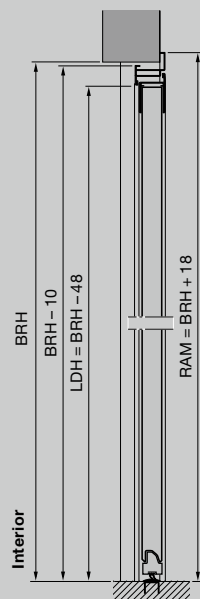

Side door with aluminium corner frame, profile type 2  
External fitting

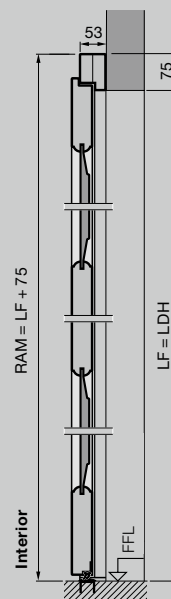

Solid timber side door  
Fitting behind the opening

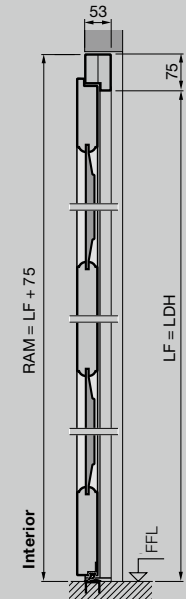

Solid timber side door  
Fitting in the opening



## Steel side doors

Ordering size = RAM	Structural opening	Lever height*		
		P1	P2	P3
<b>Block frame, fitting behind the opening (ordering size = overall frame dimension) Profile type 1 (only opening inwards) and profile type 2</b>				
990 × 2058	855 – 875 × 1990 – 2000	955	1050	
990 × 2183	855 – 875 × 2115 – 2125	1010	1050	
1115 × 2058	980 – 1000 × 1990 – 2000	955	1050	
1115 × 2183	980 – 1000 × 2115 – 2125	1010	1050	
<b>Block frame, fitting in the opening (ordering size = overall frame dimension) Profile type 2 (only S, M, L-ribbed)</b>				
855 × 1990	875 × 2000		1050	
855 × 2115	875 × 2125		1050	
980 × 1990	1000 × 2000		1050	
980 × 2115	1000 × 2125		1050	
<b>Corner frame, internal fitting (ordering size = BRB × BRM) Profile type 1 and profile type 2 (only S, M, L-ribbed)</b>				
875 × 2000		955	1050	
875 × 2125		1010	1050	
1000 × 2000		955	1050	
1000 × 2125		1010	1050	
<b>Corner frame, external fitting (ordering size = BRB × BRM) Profile type 2 (only S, M, L-ribbed) and profile type 3</b>				
875 × 2000			1050	955
875 × 2125			1050	1010
1000 × 2000			1050	955
1000 × 2125			1050	1010

## Solid timber side doors

Ordering size = RAM	Structural opening	Lever height*	
		P1	P2
<b>Fitting behind the opening (ordering size = overall frame dimension) (S, M, L-ribbed, panelled)</b>			
1005 × 2190	855 – 875 × 2115 – 2125		1050
1130 × 2190	980 – 1000 × 2115 – 2125		1050
<b>Fitting behind the opening (ordering size = overall frame dimension) (Styles 401, 403, 404, 405)</b>			
1130 × 2190	980 – 1000 × 2115 – 2125		1050

## Explanations

P1	Profile type 1 (narrow surround)
P2	Profile type 2 (broad surround)
P3	Profile type 3 (narrow surround)

LDB	Clear passage width
LDH	Clear passage height
RAM	Overall frame dimension
LF	Structural opening
BRM	Nominal size
BRB	Nominal size - width
BRH	Nominal size - height
FFL	Finished floor level

### Special sizes

Single-leaf side doors on request  
 Double-leaf side doors:  
 1200 – 2500 × 1960 – 2558

\* You can find the lever heights for special sizes in the technical manual.



# Experience Hörmann quality in new construction and modernisation

Hörmann provides an excellent basis for comprehensive planning. Carefully matched solutions offer you the very best in perfectly designed products for every area.

- **Garage doors**

Optimally match your personal architectural style: up-and-over or sectional doors made of steel, grp or timber.

- **Door operators**

Enjoy extra convenience and break-in-resistant security: Hörmann operators for garage doors and entrance gates.

- **Entrance doors**

Our comprehensive entrance door ranges include models that fit almost every need and requirement.

- **Steel doors**

Sturdy doors for your entire home, from basement to roof.

- **Frames**

Choose from our comprehensive range of products for new construction, expansion and modernisation.



Garage doors and entrance gate operators



ThermoPro entrance door



Steel doors

# HÖRMANN: QUALITY WITHOUT COMPROMISE



Hörmann KG Amshausen, Germany



Hörmann KG Antriebstechnik, Germany



Hörmann KG Brandis, Germany



Hörmann KG Brockhagen, Germany



Hörmann KG Dissen, Germany



Hörmann KG Eckelhausen, Germany



Hörmann KG Freisen, Germany



Hörmann KG Ichttershausen, Germany



Hörmann KG Werne, Germany



Hörmann Genk NV, Belgium



Hörmann Alkmaar B.V., Netherlands



Hörmann Legnica Sp. z o.o., Poland



Hörmann Beijing, China



Hörmann Tianjin, China



Hörmann LLC, Montgomery IL, USA



Hörmann Flexon LLC, Burgettstown PA, USA

Hörmann is the only manufacturer worldwide that offers you a complete range of all major building products from one source. We manufacture in highly-specialised factories using the latest production technologies. The close-meshed network of sales and service companies throughout Europe, and activities in the USA and China, make Hörmann your strong partner for first-class building products, offering "Quality without Compromise".

**GARAGE DOORS**  
**OPERATORS**  
**INDUSTRIAL DOORS**  
**LOADING EQUIPMENT**  
**HINGED DOORS**  
**DOOR FRAMES**

**Hörmann (UK) Ltd**, Gee Road, Coalville, Leicestershire LE67 4JW  
Phone (01530) 513000, Fax (01530) 513001

